

DETAIL B
SCALE 2 : 1

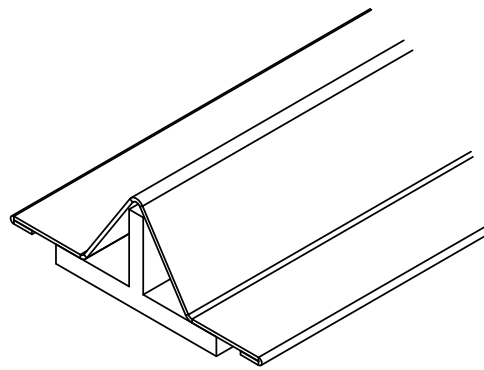
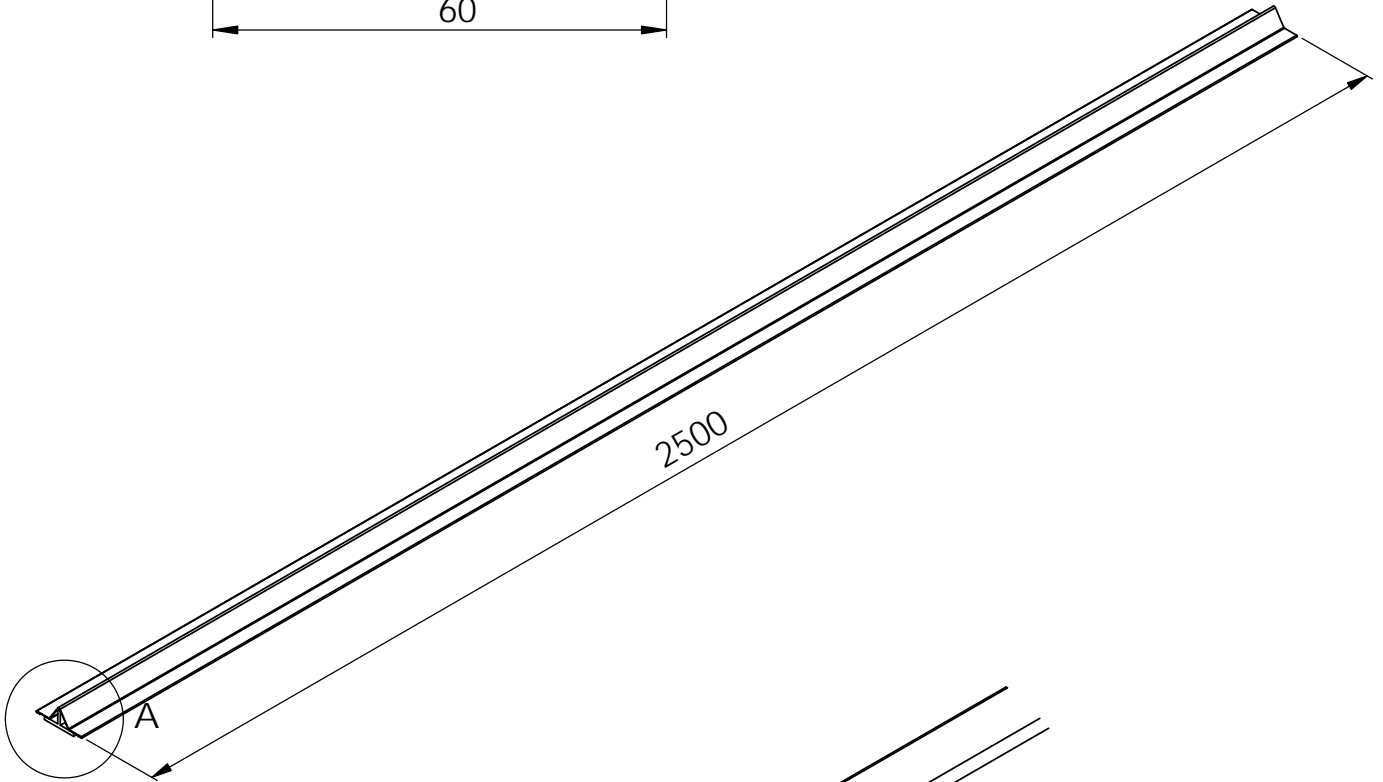

DETAIL A
SCALE 1 : 2